

# Spring Sash Window Section

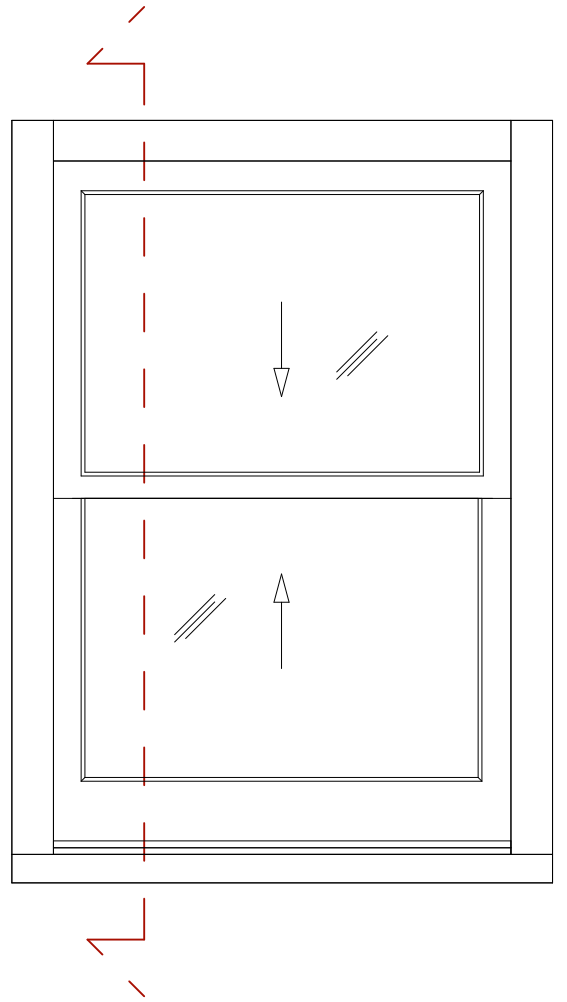

Cill and Meeting Rails Detail

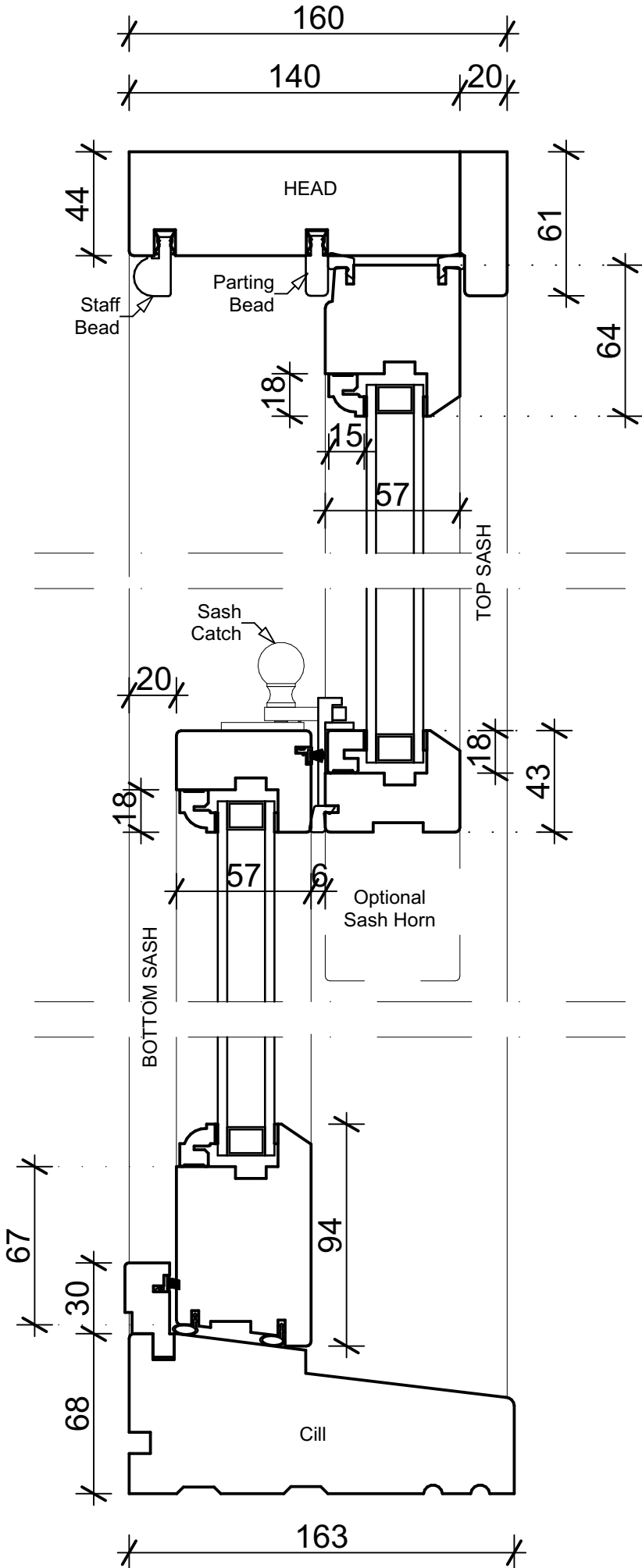
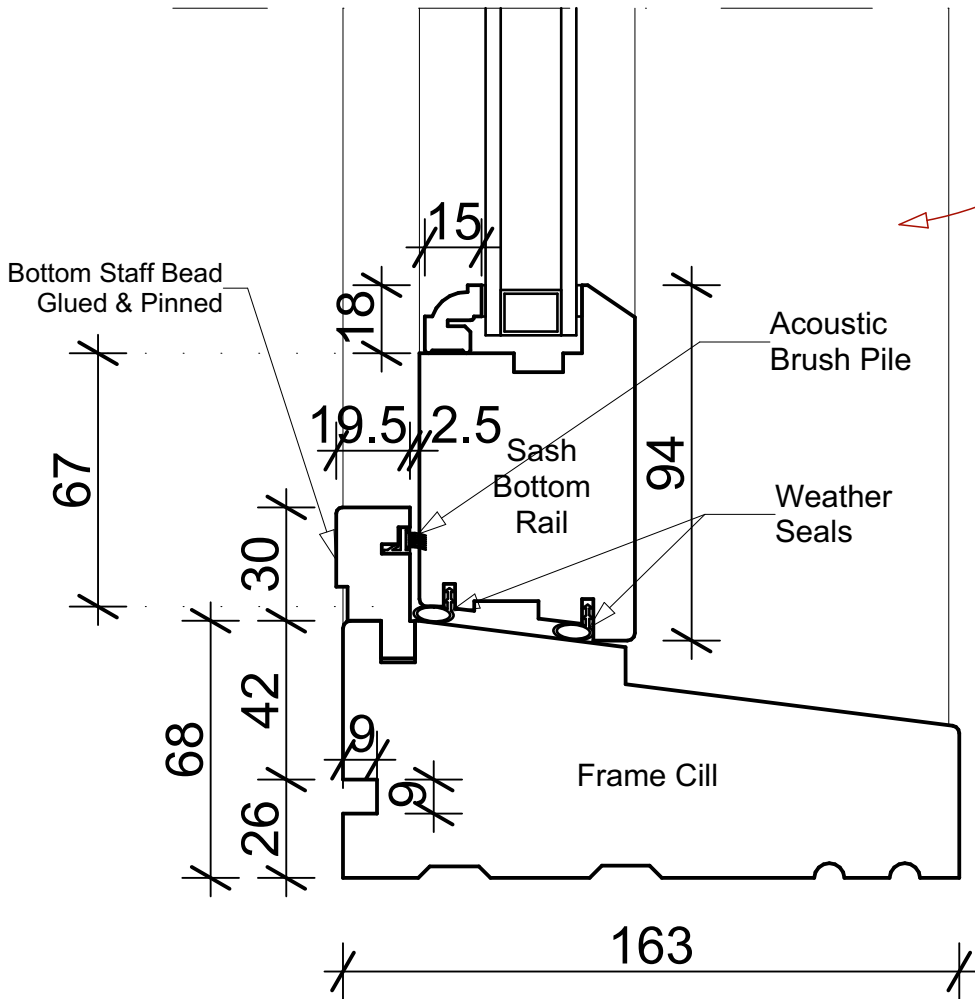
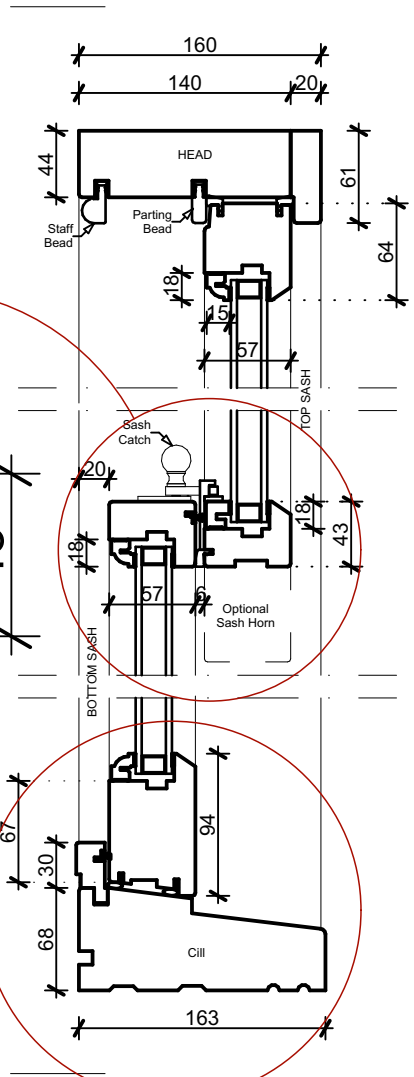
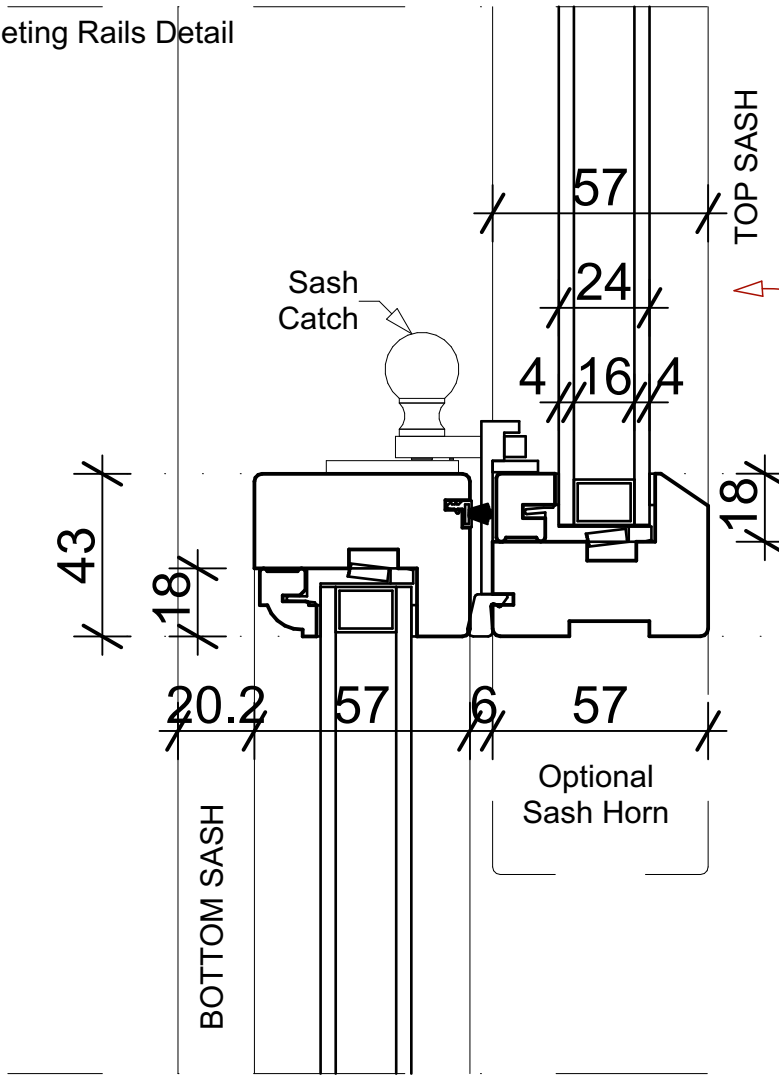

40.4

Window Board groove as standard  
Optional no Window Board groove

Jamb Section

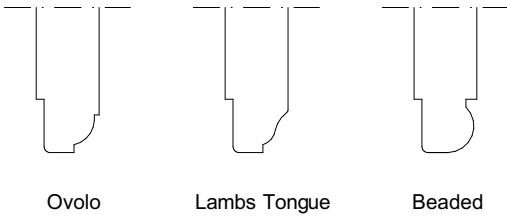

Ovolo      Lambs Tongue      Beaded

External Liners can be Square Profile as shown, Ovolo, Lambs Tongue or Beaded

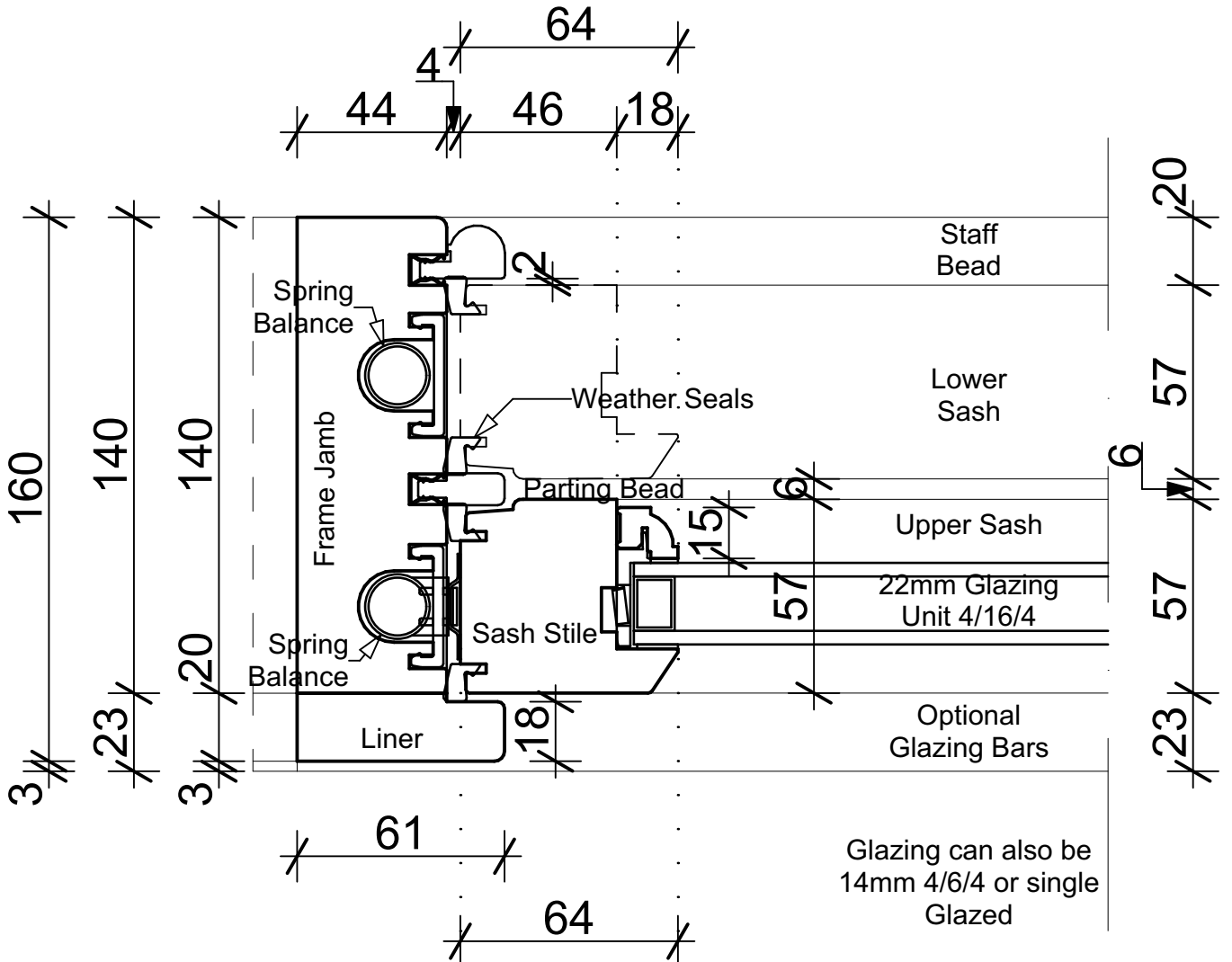
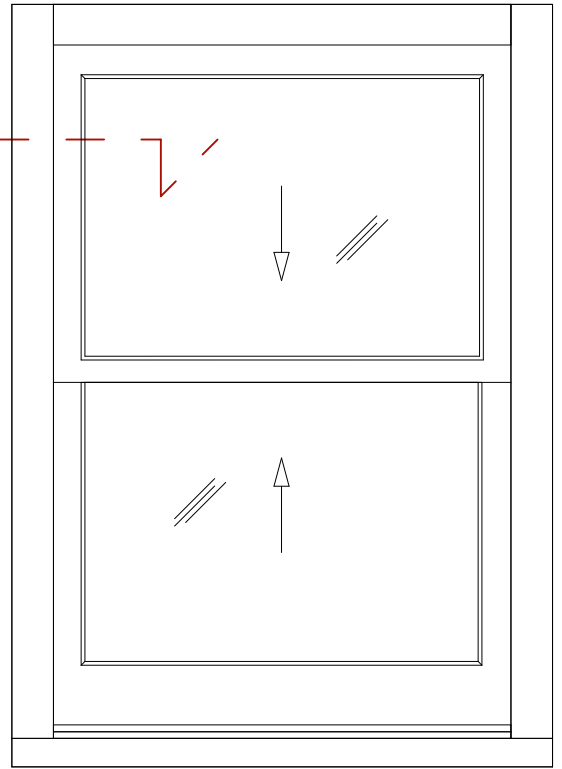

Sash Restrictor Locks

If frame width is over 1148mm  
locks are fitted to both sides

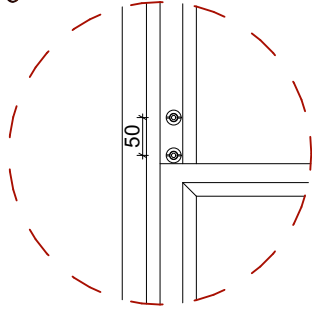

Locks 50mm apart allows an  
opening of 20mm between  
bottom of sash and staff bead

20

O/A Frame width up to  
1148 Locks fitted to one side only

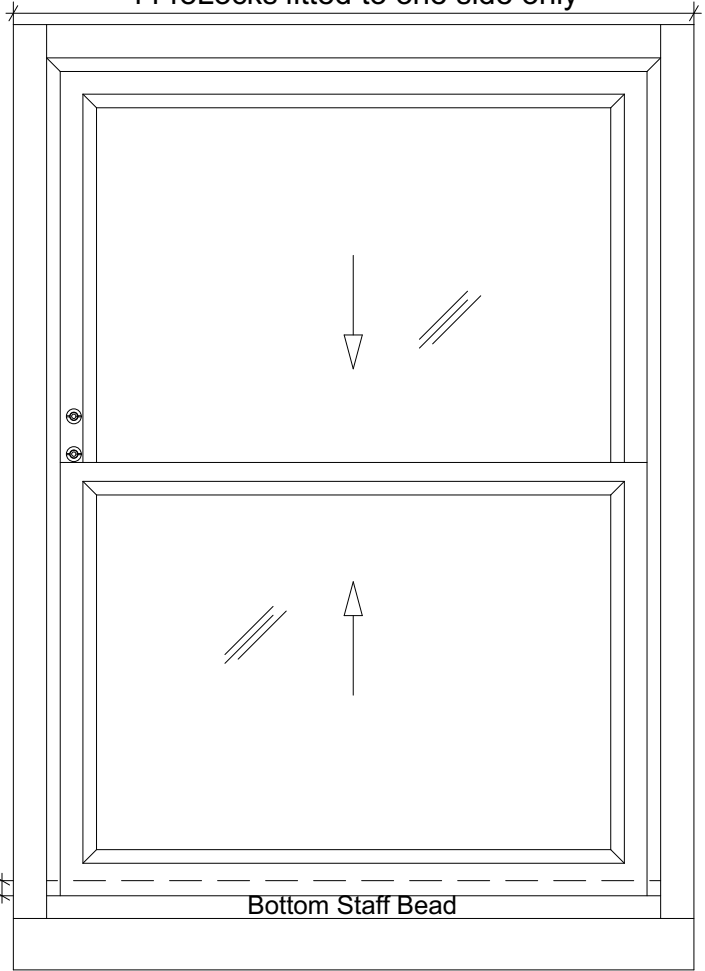

VIEWED FROM INSIDE

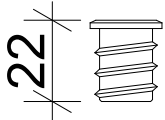

BARREL LOCK

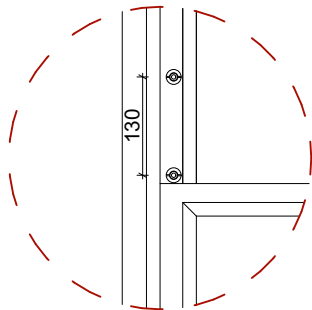

Locks 130mm apart allows an  
opening of 100mm between  
bottom of sash and staff bead

100

O/A Frame width up to  
1148 Locks fitted to one side only

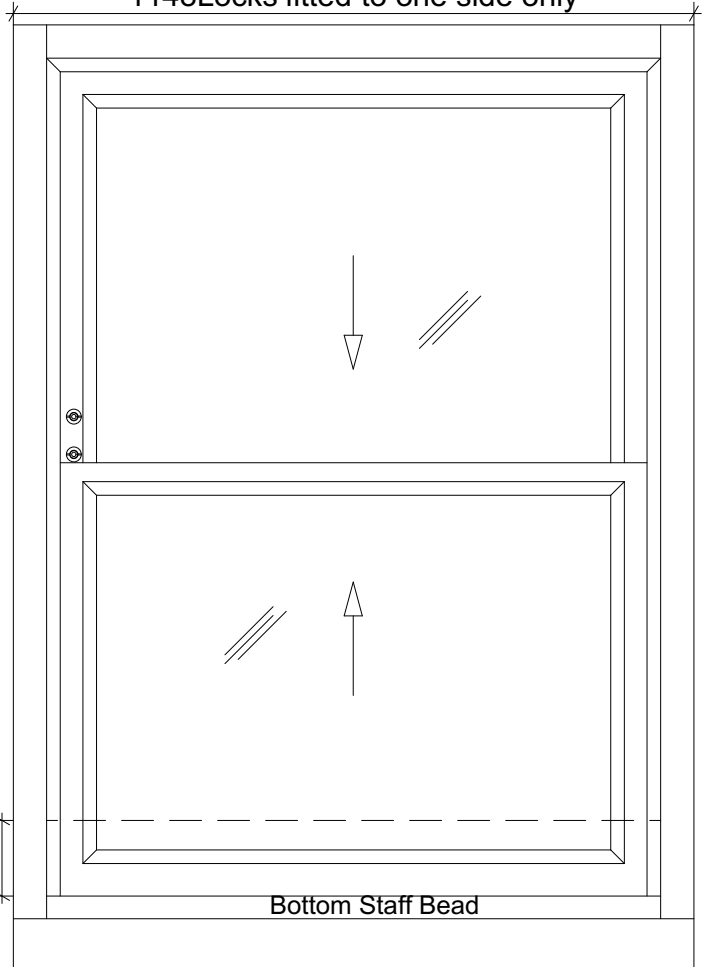

VIEWED FROM INSIDE

### HEAD

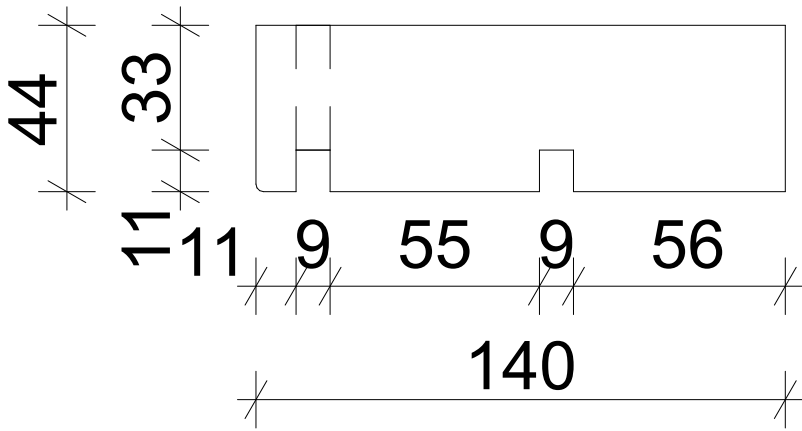

### Liner x2

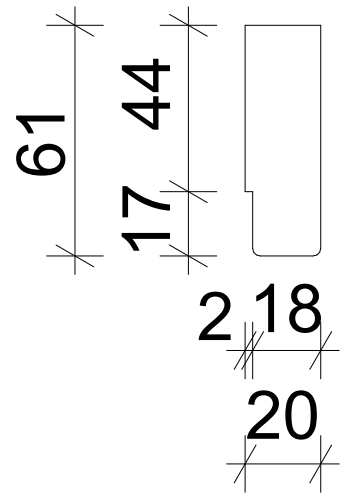

### Frame Jamb x2

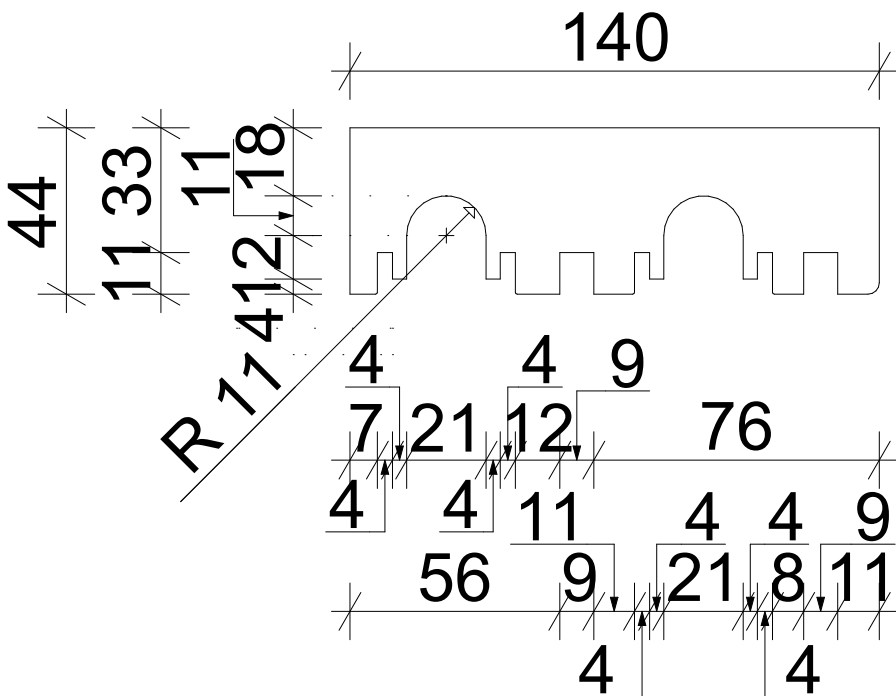

### Parting Bead x3

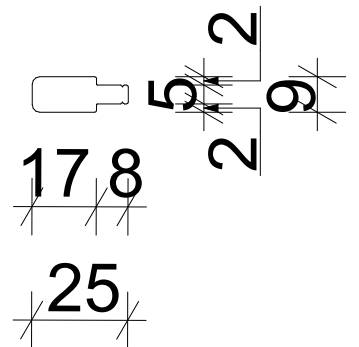

Sash Stile x5

Staff Bead x3

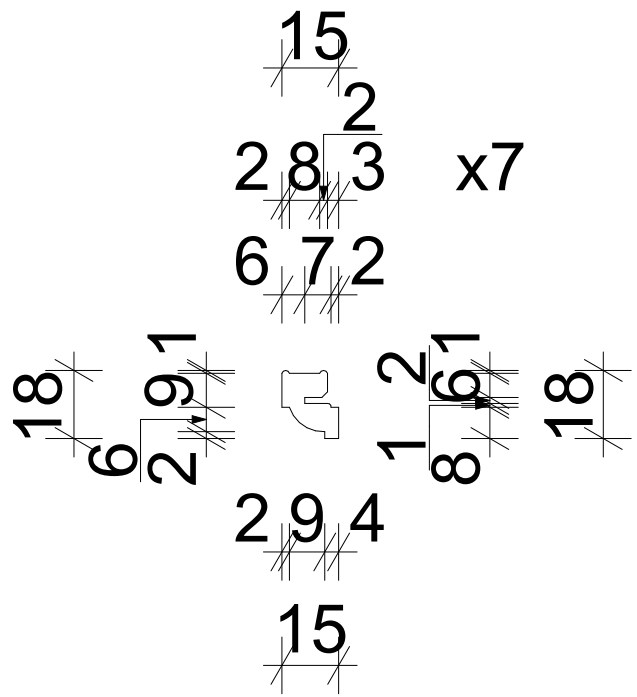
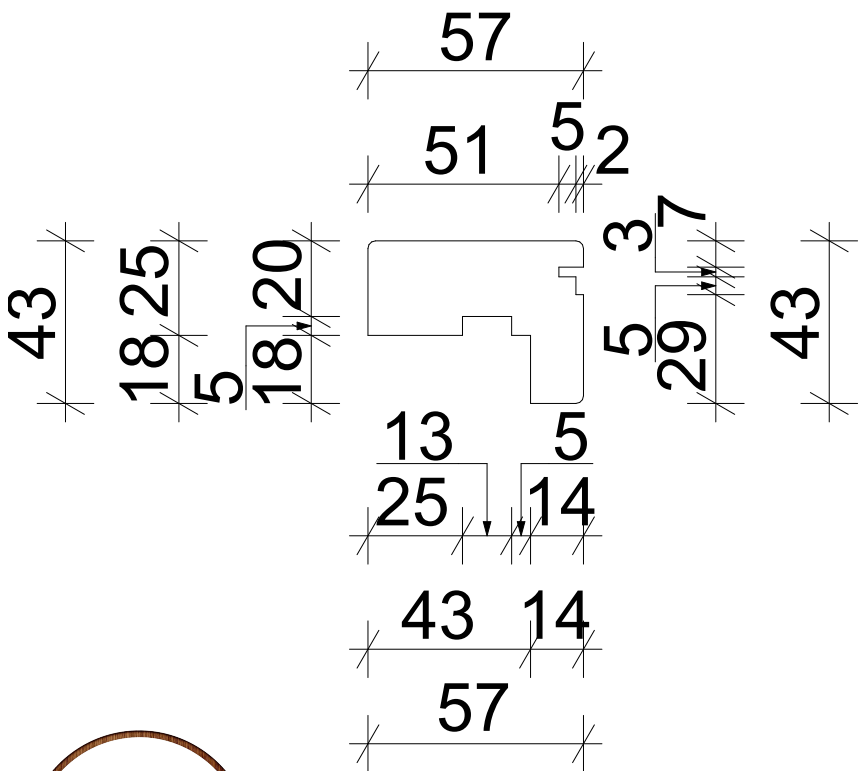
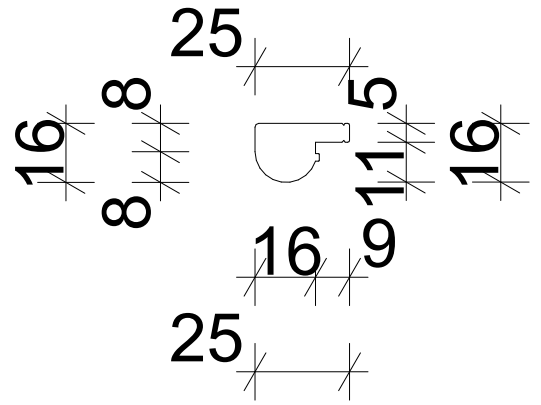
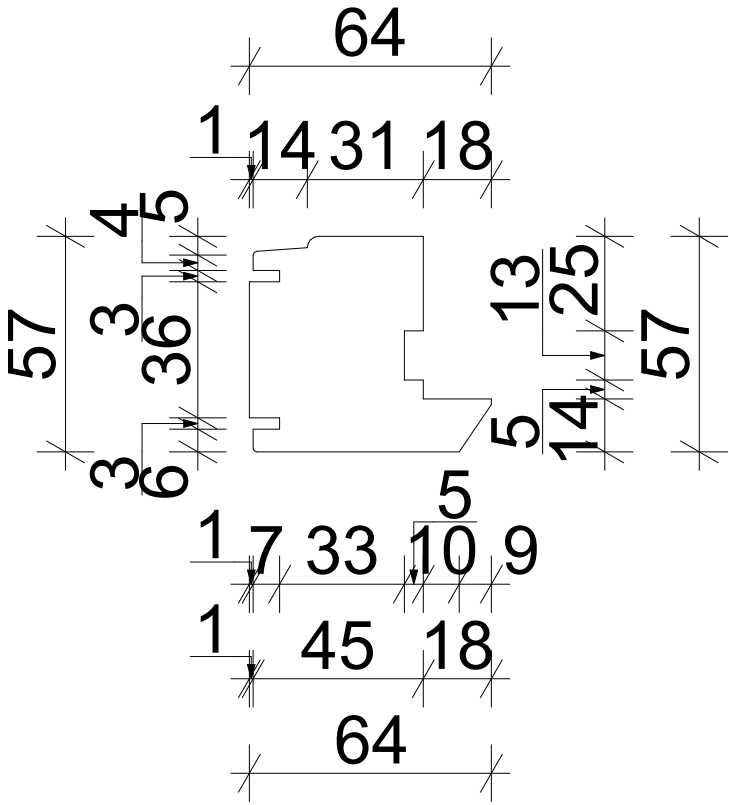

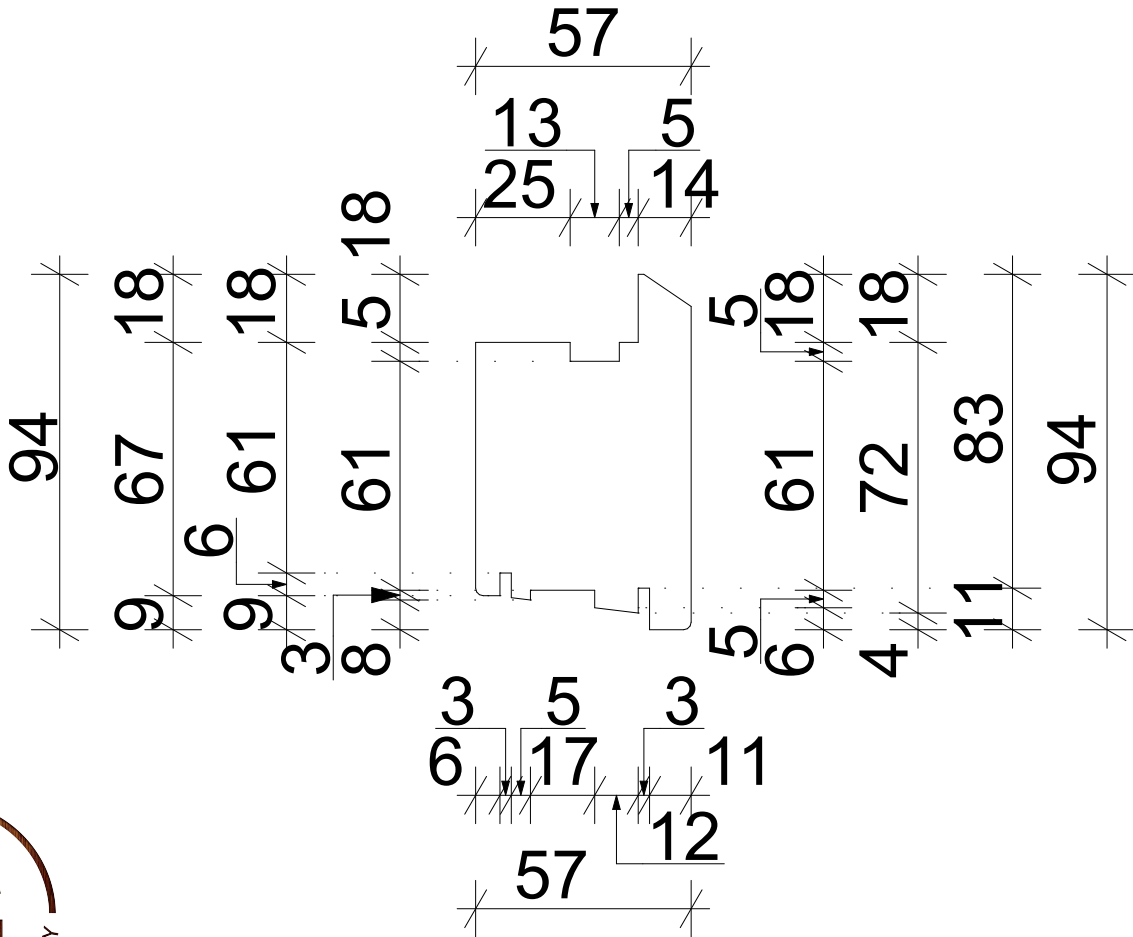
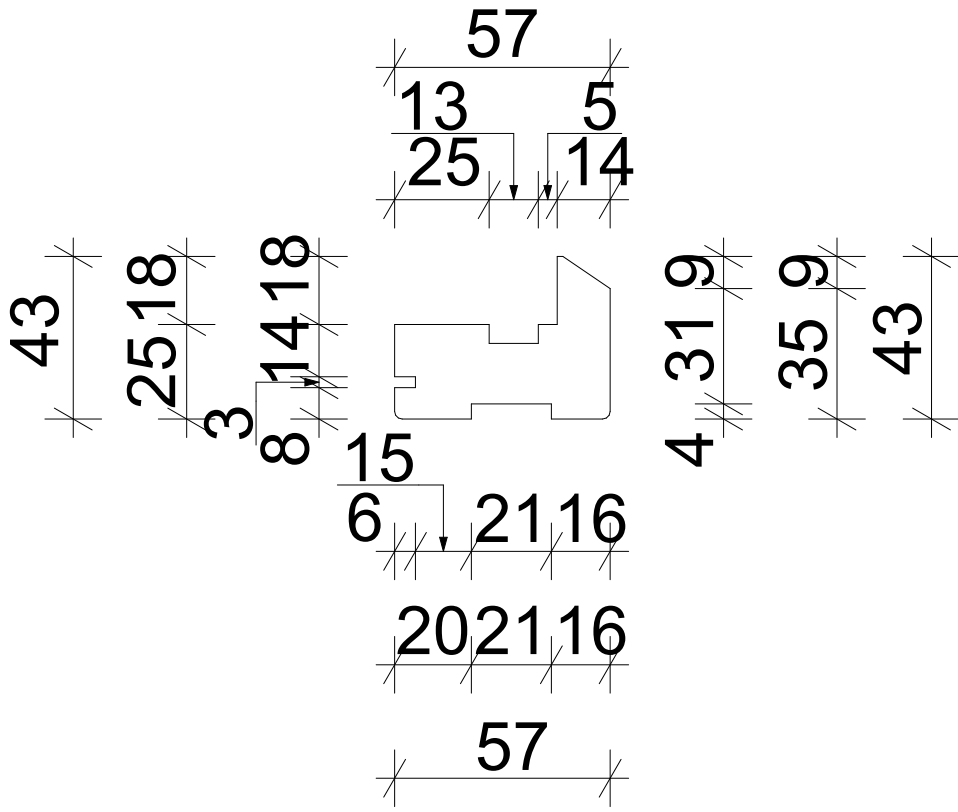

### Bottom Staff Bead Glued & Pinned

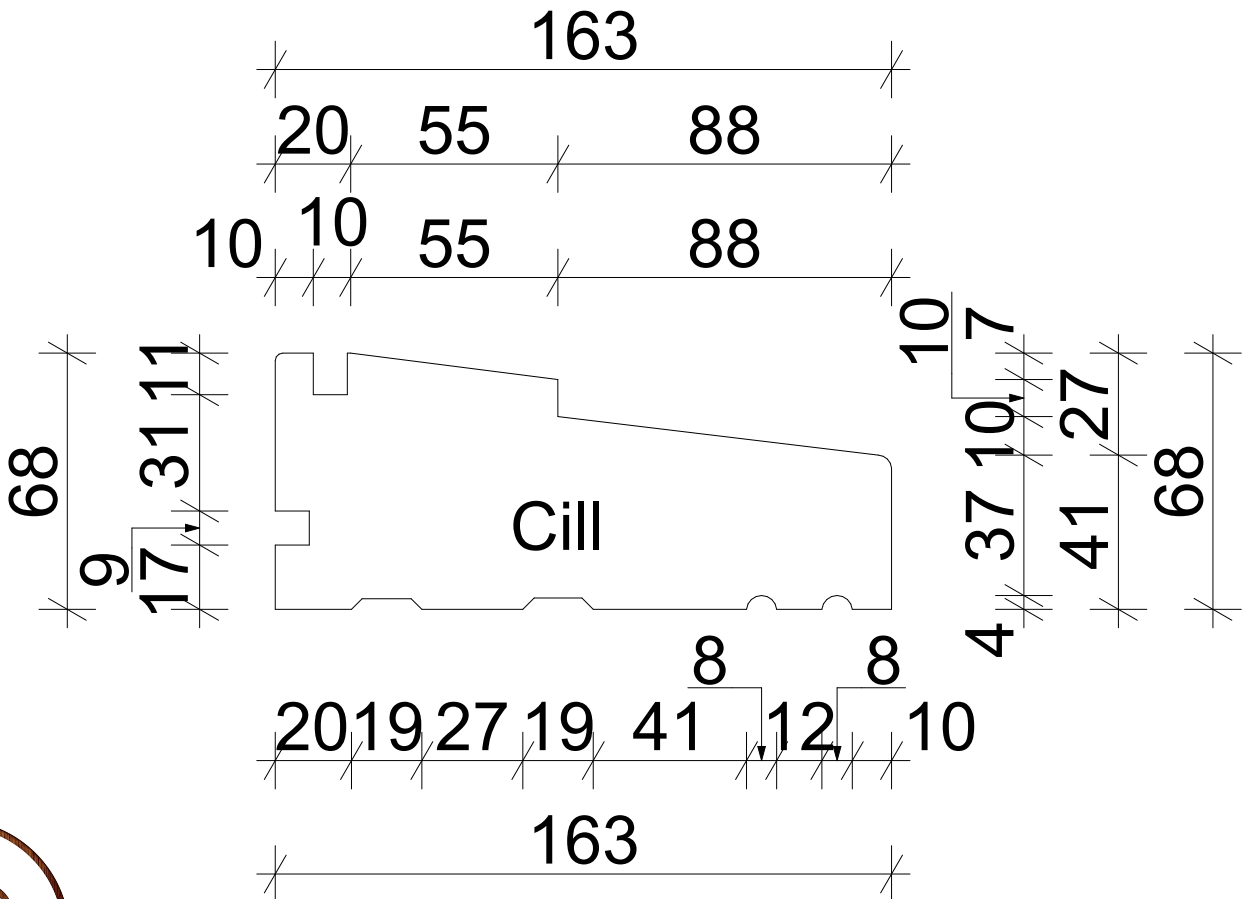
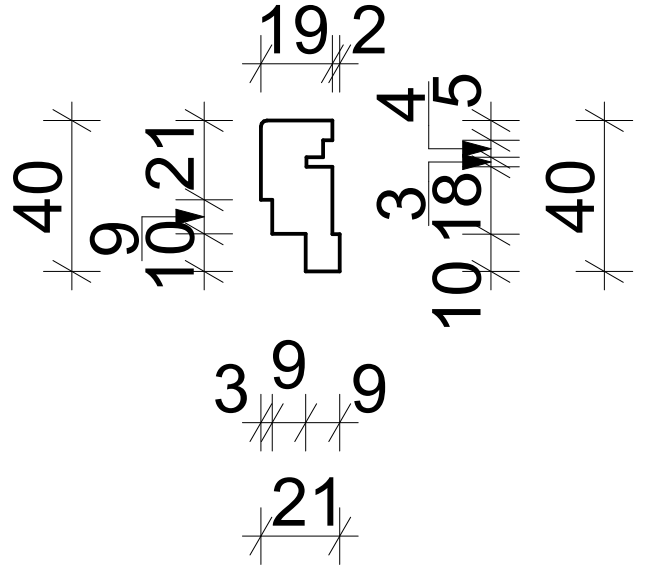
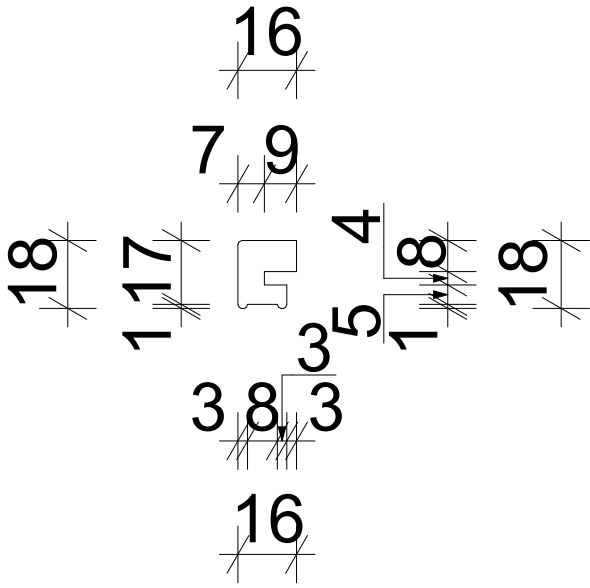



Spring Sash Window 3D

